

Courbes de charges	45 m	3 ▶	11,7	13	15	17	20	23	25	27	30	33	35	37	40	43	45	m
			6000	5265	4400	3770	3090	2600	2345	2130	1865	1655	1535	1430	1290	1170	1100	kg
Lastkurven																		
Load diagrams																		
Curvas de cargas	40 m	3 ▶	12,4	13	15	17	20	23	25	27	30	33	35	37	40		m	
			6000	5650	4730	4055	3325	2800	2530	2300	2020	1790	1660	1550	1400		kg	
Curve di carico																		
Curva de cargas																		
LVE 1	35 m	3 ▶		13,1	15	17	20	23	25	27	30	33	35				m	
				6000	5080	4360	3580	3020	2725	2480	2180	1940	1800				kg	
	28 m	3 ▶		13,6	15	17	20	23	25	27	28						m	
				6000	5330	4580	3760	3175	2870	2615	2500						kg	

Flèche relevée
Ausleger in Steilstellung
Luffing jib
Flecha izada
Braccio impennato
Lança inclinada

LVE 1

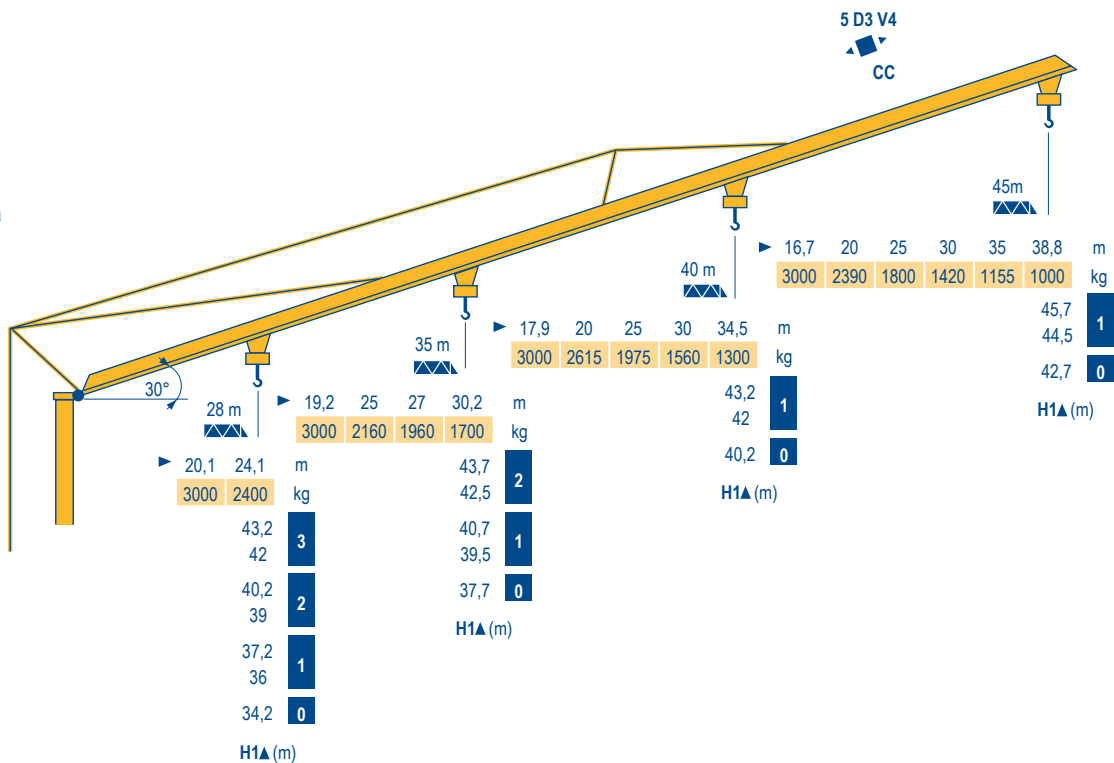















GTMR 346 B



F CC	Chariot distributeur et courbes de charges	D	Verfahrbare Laufkatze und Lastkurven	GB	Traversing trolley and load diagrams	E	Carro distribuidor y curvas de cargas	I	Carrellino distributore e curve di carico	P	Carro distribuidor e curva de cargas
●	Réactions en service	●	Reaktionskräfte in Betrieb	●	Reactions in service	●	Reacciones en servicio	●	Reazioni in servizio	●	Reacções em serviço
■	Réactions hors service	■	Reaktionskräfte außer Betrieb	■	Reactions out of service	■	Reacciones fuera de servicio	■	Reazioni fuori servizio	■	Reacções fora de serviço
▲	A vide sans lest (ni train de transport) avec flèche et hauteur maximum.	▲	Ohne Last, Ballast (und Transportachse), mit Maximalausleger und Maximalhöhe.	▲	Without load, ballast (or transport axles), with maximum jib and maximum height.	▲	Sin carga, sin lastre, (ni tren de transporte), flecha y altura máxima.	▲	A vuoto, senza zavorra (ne assali di trasporto) con braccio massimo e altezza massima.	▲	Sem carga (nem trem de transporte)- sem lastro com lança e altura máximas.

Mécanismes
Antriebe
Mechanisms
Mecanismos
Meccanismi
Mecanismos

LVE 2

									ch - PS hp	kW
										
	20 LVF 15	m/min	5,5	27,5	55	2,7	13,7	27,5	20	15
		Kg	3000	3000	1500	6000	6000	3000		
	5 D3 V4	m/min	15 - 30 - 58						5,5	4
	RCV 51	tr/min U/min rpm	0 → 0,8						6	4,4
 R ≥ 8 m	TDV 324	m/min	25						2 x 4	2 x 3
	TB 124	m/min	25						2 x 4	2 x 3
CEI 38 			IEC 38							
400 V (+6% -10%) 50 Hz			30 kVA							





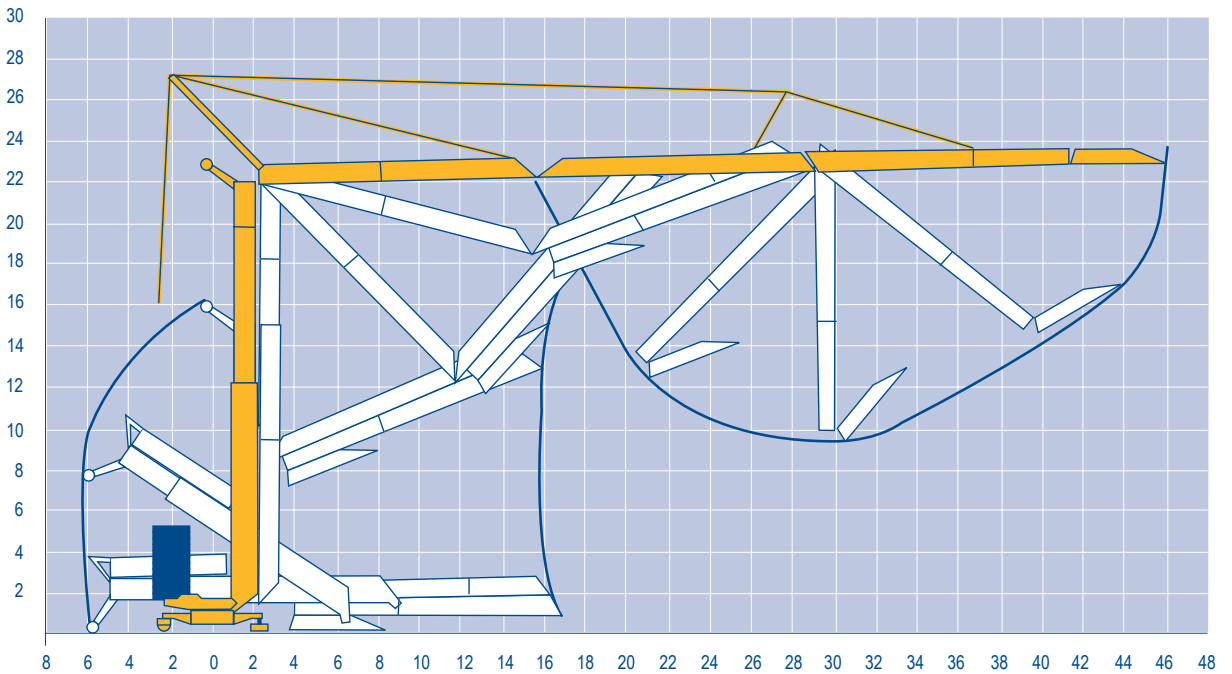













Montage
Montage
Erection
Montaje
Montaggio
Montagem

LVE 1



GTMR 346 B

POTAIN 

F	D	GB	E	I	P
					
Levage	Heben	Hoisting	Elevación	Sollevamento	Elevação
					
Distribution	Katzfahren	Trolleying	Distribución	Distribuzione	Distribuição
					
Orientation	Schwenken	Slewing	Orientación	Rotazione	Rotação
					
Translation	Kranfahren	Travelling	Traslación	Traslazione	Translação

Transport
 Transport
 Transport
 Transporte
 Trasporto
 Transporte

LVE 1

DJ126M/S215M

15A/25A

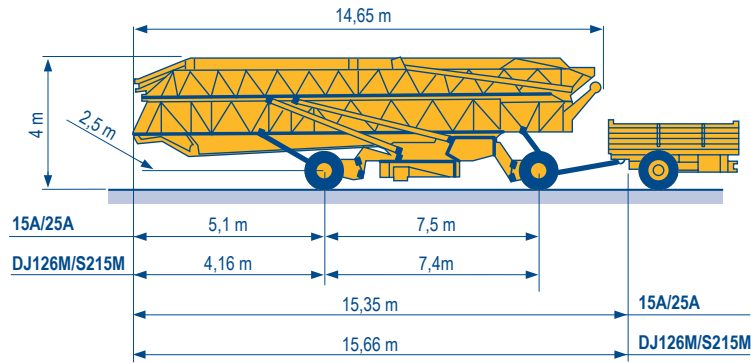

S4/S215M

S5B/J215M

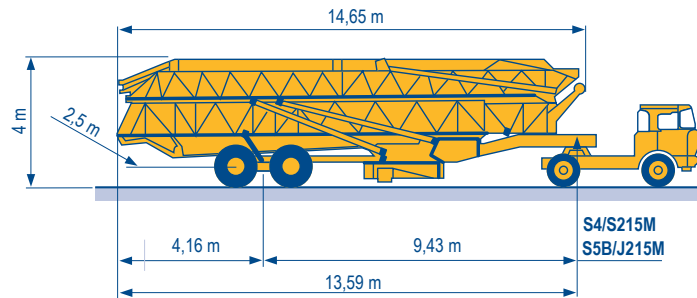

Document commercial non contractuel. Pour toute information technique se référer à la notice correspondante.

Unverbindliches Vertriebsdokument. Für technische Informationen, siehe die entsprechenden Anweisungen.

This commercial document is not legally binding. For any technical information, please refer to the corresponding instructions.

Documento comercial non contractuel. Para cualquier información técnica, ver la noticia correspondiente.

Documento commerciale non vincolante, per tutte le informazioni tecniche fare riferimento al catalogo istruzioni.

Documento comercial não contratual. Para qualquer informação técnica complementar consultar as respectivas instruções.

Manitowoc
 Crane CARE

POTAIN
 Manitowoc Crane Group



Americas

Tel : +1 888 479 7278
 Tel : +1 717 593 2000

Europe - Middle East - Africa

Tel : +33 (0) 4 72 81 50 00
 Tel : +44 (0) 191 522 2000

Asia - Pacific

Tel : +65 6264 1188
 Fax : +65 6862 4142

www.manitowoccrane.com

18, rue de Charbonnières - B.R.173
 69132 ECULLY Cedex - France

Tél. : +33 (0) 4 72 18 20 20
 Fax. : +33 (0) 4 72 18 20 00
www.manitowoccrane.com

GTMR 346 B
 Réf. 2003 48 LVE 3

Copyright.Reproduction interdite © POTAIN 2003

Réalisation Secloc